

SENATOR

PAILO

PAILO

With every Senator design comes a great deal of thought. The design process starts way before pencil reaches paper, beginning with looking at you. We look at how you sit, reach, move and work to create a design which not only looks beautiful, but is a pleasure to use too.

Behind every Senator product is a fusion of intelligent thinking and innovative engineering to create products which support people whether they're focusing, collaborating, presenting or organizing.

PAILO

STANDARD FEATURES (*Selected models only)

- Solid Ash sculpted legs
- Tooled Aluminum components
- Hidden frame attachments
- Leveling feet
- Scalloped cable access
- 1" TFL table tops (Edge 69), or 1" Laminate on ply tops (Edge 33)

SPECIFIABLE FEATURES

- In-line or back to back frames

COMPLEMENTARY OPTIONS

- Desk gantry for hanging screens
- Adjustable drupe screens
- Hanging screens
- Bench desk cloud screens
- Single desk cloud screens (integrated modesty panel)
- Suspended lighting
- In-desk power modules for project tables
- Cable trays in accent colors
- Wire under-desk storage caddy

ACCESSORIES

- Monitor arms
- Electrical accessories

PERFORMANCE STANDARDS

Designed to conform to and where applicable is tested to the following standards:

- BIFMA X5.5 x2014

DIMENSIONS

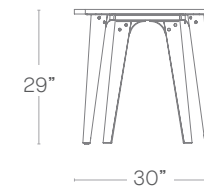

Single desk

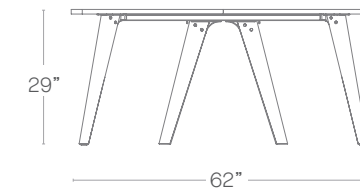

Back to back bench

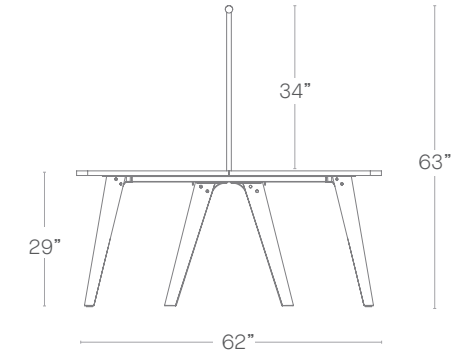

Back to back bench with gantry



Single executive desk
Widths. 48" - 78"
Depth. 30"



Stand alone desk
Widths. 48" - 78"
Depth. 30"



2 Person in-line desk

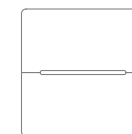

2 Person cluster
Widths. 48" - 78"
Depth. 62"



4 Person cluster

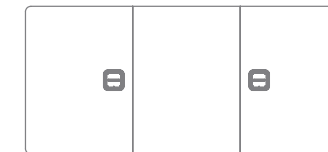

Project table
Widths. 96" - 192"
Depth. 62"

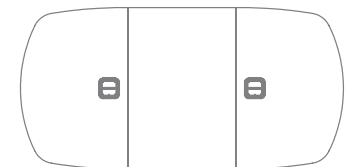

Boat shaped project table
Widths. 96" - 192"
Depth. 72"

STATEMENT OF LINE

PAILO SINGLE DESKS

Single Desk



● Available
□ Not available

	Starter desk	Mid add on	End desk		
	48" W	54" W	60" W	72" W	78" W
30" D	●	●	●	●	●

Single Stand Alone Desk

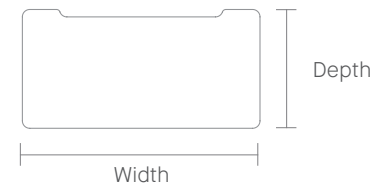

	48" W	54" W	60" W	72" W	78" W
30" D	●	●	●	●	●

Executive Single Desk



	48" W	54" W	60" W	72" W	78" W
30" D	●	●	●	●	●

Single Desk Screens / Cable Trays

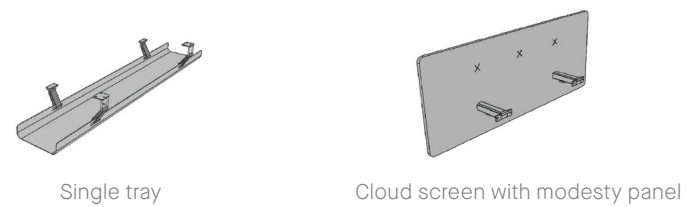

	Single tray	Cloud screen with modesty panel			
	48" W	54" W	60" W	72" W	78" W
	●	●	●	●	●

STATEMENT OF LINE

PAILO BACK TO BACK DESKS

Back to Back Desk

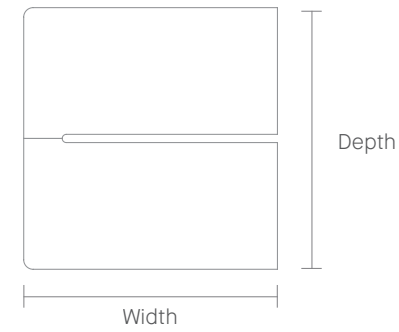

● Available
□ Not available

	Starter desk	Mid add on	End desk		
	48" W	54" W	60" W	72" W	78" W
62" D	●	●	●	●	●

Stand Alone Back to Back Desk

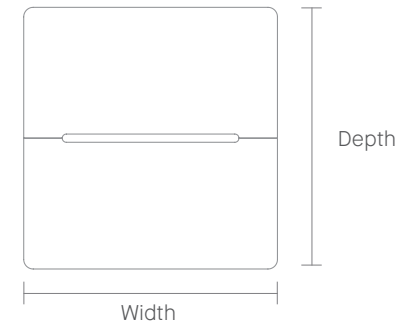

	48" W	54" W	60" W	72" W	78" W
62" D	●	●	●	●	●

Back to Back Desk Screens / Cable Trays



	Double cable tray	Cloud screen			
	48" W	54" W	60" W	72" W	78" W
	●	●	●	●	●

Wire Management



Vertical cable riser

PAILO SCREENS AND ACCESSORIES

● Available
□ Not available

Gantry



Stand alone gantry



Starter gantry



Mid and end add on gantry

48" W	54" W	60" W	72" W	78" W
●	●	●	●	●

Screens

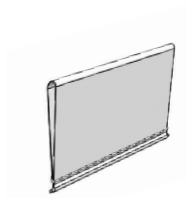

Adjustable drape screen

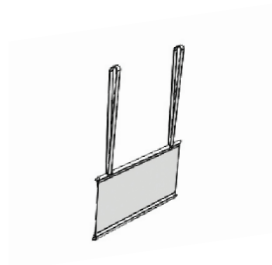

Hanging screen

48" W	54" W	60" W	72" W	78" W
●	●	●	●	●

Accessories

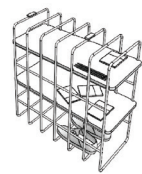

Wire caddy

PAILO PROJECT TABLES

● Available
□ Not available

Project Table

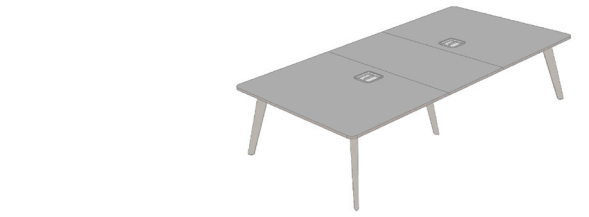
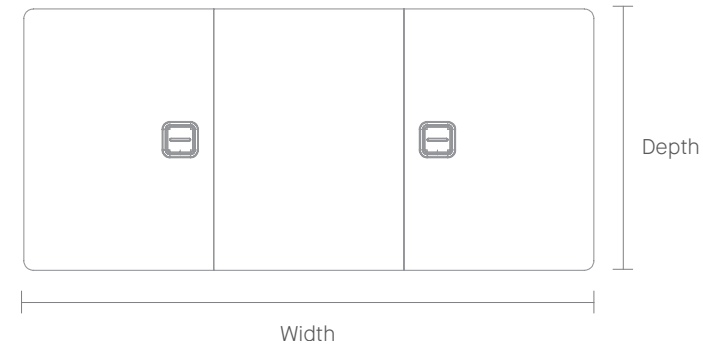

62" D	96" W	144" W	192" W
	●	●	●

Boat Shaped Project Table

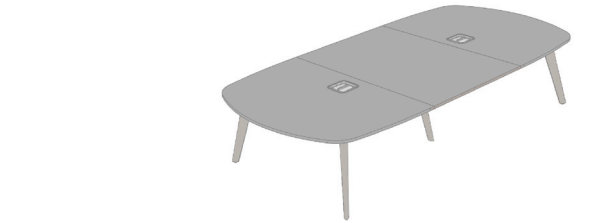
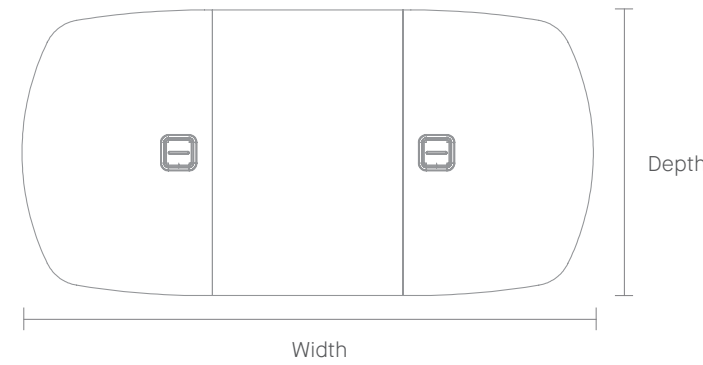

72" D	96" W	144" W	192" W
	●	●	●

PAILO SINGLE DESK

STARTER DESK

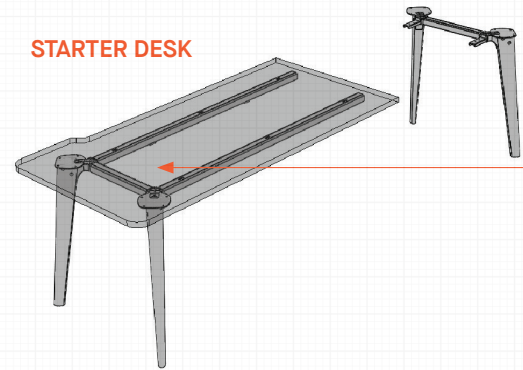

In-line desks are created by connecting an add on desk to a starter desk. You are able to link as many add on desks as necessary to complete your configuration.

Starter Desk
A Starter Desk is comprised of (2) end legs, (2) beams, (1) starter work surface and all corresponding hardware.

MID ADD ON

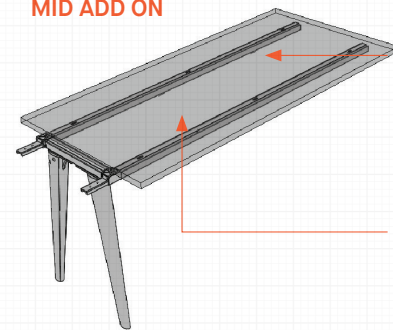

Beams
Beams connect the legs together and support the tops. The beams feature an extruded profile which can be used to attach accessories.

Mid Add On
A Mid Add On desk is comprised of (1) mid leg, (2) beams, (1) mid work surface and all corresponding hardware and components.

END ADD ON

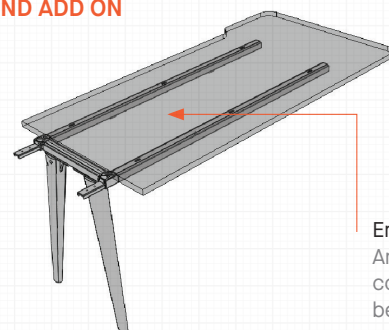

End Add On
An End Add On desk is comprised of (1) mid leg, (2) beams, (1) end work surface and all corresponding hardware and components.

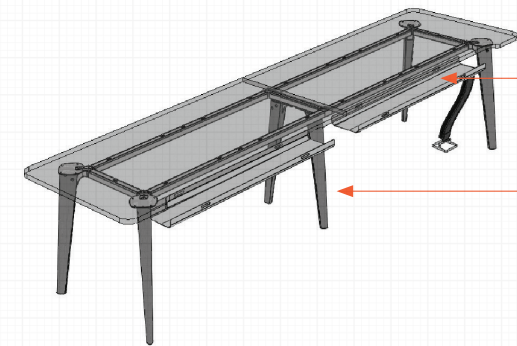

Cable Tray
Cable trays are available to manage power options. (1) Single cable tray is needed per starter desk and every additional add on.

Vertical Riser
The vertical riser is used to transport power cables from the ground to the cable tray. It is attached to the underside of the cable tray and can be positioned along the tray for central desk or end desk fed power.

BENCH WITH SCREENS

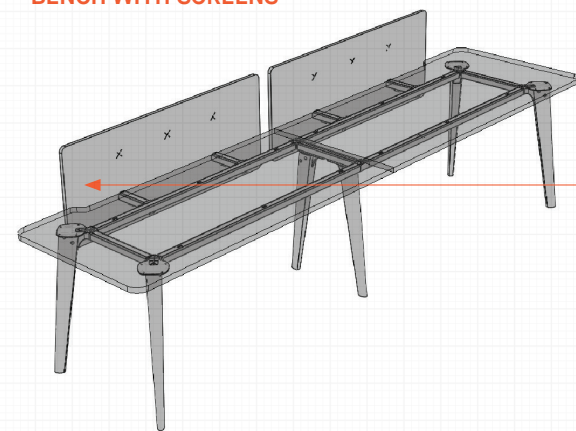

Screen / Modesty Panel
Screens are also available to separate benches to allow for more private working. The screens for single desks extend below the desk surface to act as an integral modesty panel.

WORK SURFACES

On single benches, one top is supplied per starter desk.

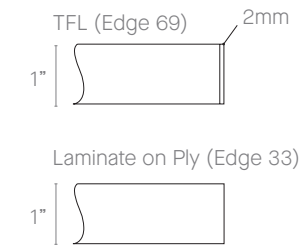
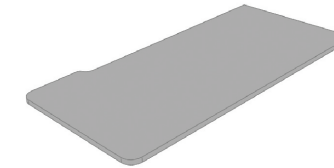

Pailo tops are available in 30" depth and lengths of 48", 54", 60", 72" and 78". Surfaces can be specified in TFL (Edge 69) or Laminate faced plywood.

FRAMEWORK

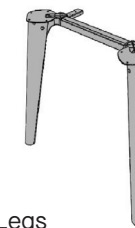

End Legs
Single end legs are for 30" deep tops. Each end leg has spigots protruding from the frame to allow the beam to be attached into place. Adjustable feet are standard.

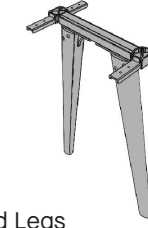

Mid Legs
Mid legs are used to connect starter desks and add-on desks. They have double sided spigots to attach beams to both sides and come with adjustable feet as standard.

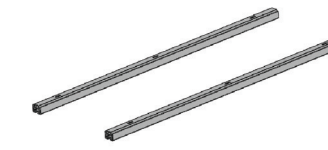

Beams
Extruded Aluminum beams are used to connect the legs together. They bolt at each end to the spigots and also through to the top with a channel to hide the attachments. Beams come in widths of 48", 54", 60", 72" and 78".

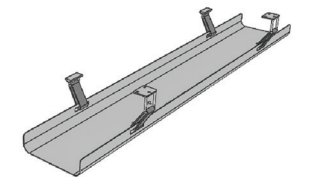

Cable Trays
Cable trays hang from the beams using leather straps. These allow for power blocks to be housed along with any wires or loose cables.

SCREENS AND ACCESSORIES



Vertical Riser
An optional fabric vertical cable riser with zip opening is available to allow power cables to be taken neatly from the floor to the cable tray or directly to the work surface. The riser attaches to the cable tray and has a weighted wire base. Available in black fabric.

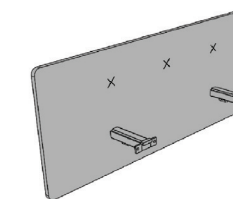

Cloud Screen with Modesty Panel
The cloud screen mounts directly to the desks understructure. The screens for single desks extend below the desk surface to act as an integral modesty panel. Cloud screens measure 40.5" from the floor to the top of the screen.



Above Desk Power
An optional above desk power module can be added for convenient power access. 2 power outlets, and 2 charging USB ports are included. Above desk power is available with a 10 foot 3 prong plug, or 10 foot hardwire infeed.

PAILO BACK TO BACK BENCH

STARTER DESK

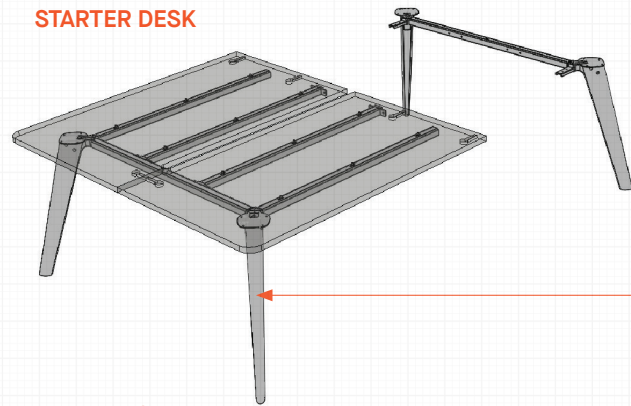

Benches are created by connecting an add on desk to a starter desk. You are able to link as many add on desks as necessary to complete your configuration.

Starter Bench

A Starter bench is comprised of (2) end legs, (4) beams, (2) starter work surfaces and all corresponding hardware and plastic components.

MID ADD ON

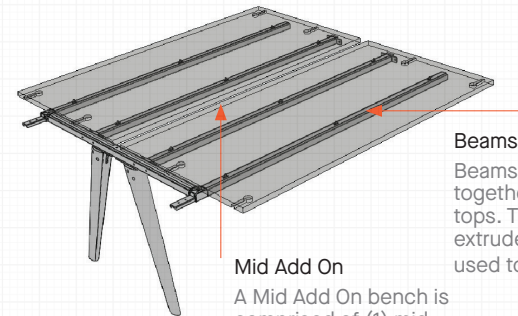

Mid Add On

A Mid Add On bench is comprised of (1) mid leg, (4) beams, (2) mid work surfaces and all corresponding hardware and components.

Beams

Beams connect the legs together and support the tops. The beams feature an extruded profile which can be used to attach accessories.

END ADD ON

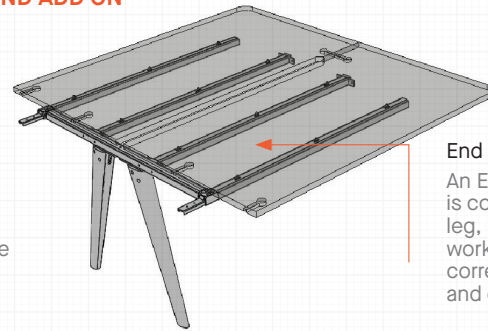

End Add On

An End Add On bench is comprised of (1) mid leg, (4) beams, (2) end work surfaces and all corresponding hardware and components.

BENCH WITH CABLE MANAGEMENT

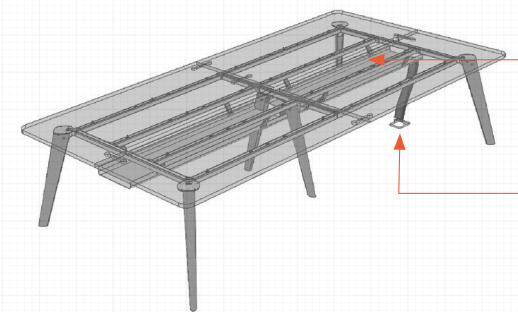

Cable Tray

Cable trays are available to manage power options. (1) Single cable tray is needed per starter desk and every additional add on.

Vertical Riser

The vertical riser is used to transport power cables from the ground to the double cable tray. It is attached to the underside of the cable tray and can be positioned at either end of the cable tray.

CLOUD SCREENS

Screens are also available to separate benches to allow for more private working.

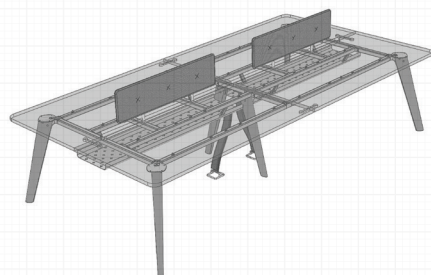

ADJUSTABLE / HANGING SCREEN

Gantry

The gantry can be used to hang screens, lighting and personal accessories.

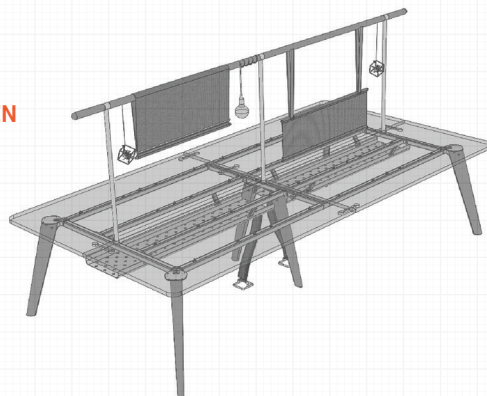

WORK SURFACES

On back to back benches two tops are supplied. Back to back configurations will result in 62" overall depths due to central gap for cable access.

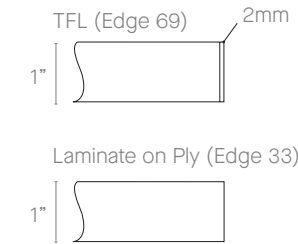
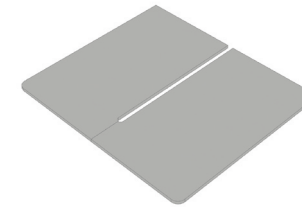

Pailo tops are available in 62" depth and lengths of 48", 54", 60", 72' and 78". Surfaces can be specified in TFL (Edge 69) or Laminate faced plywood.

FRAMEWORK



End Legs

Bench end legs are 62" wide. Each end leg has spigots protruding from the frame to allow the beam to be attached into place. Adjustable feet are fitted as standard.



Mid Legs

Mid legs are used to connect starter desks and add-on desks. They have double sided spigots to attach beams to both sides and come with adjustable feet as standard.



Beams

Extruded aluminum beams are used to connect the legs together. They bolt at each end of the spigots and also through the top with a channel to hide the fixings. Beams are available to suit the table widths of 48", 54", 60", 72" and 78".

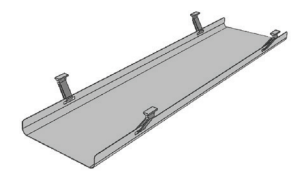

Cable Trays

Cable trays hang from the beams from leather straps. These allow for power blocks to be housed along with any wires or loose cables.

SCREENS AND ACCESSORIES

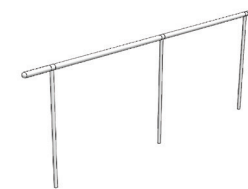

Gantry

The gantry mounts directly to the desks understructure and can be used to hang accessories such as screens and lighting. Constructed of metal uprights and a wooden top rail.



Adjustable drape screen

The adjustable drape screen is for use with the gantry. The fabric screen is suspended and can be raised or lowered by the user depending on the amount of privacy desired.

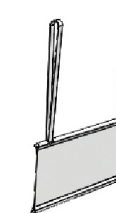

Hanging screen

The hanging screen is for use with the gantry. The fabric screen is suspended via 2 bridle leather straps.

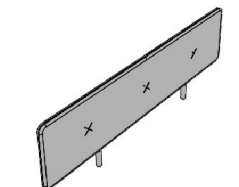

Cloud screen

The cloud screen mounts directly to the desk frame. Screens feature an 'X' detail in the screen upholstery. Cloud screens measure 41" from the floor to the top of the screen.

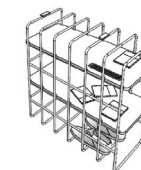

Wire caddy

The wire caddy is suspended from the desk beams and includes 2 adjustable shelves to allow personal belongings to be kept off the floor and close to hand. When the shelves are removed, the Wire Caddy can be used as a CPU holder. Available in 6 accessory colors.



Vertical Riser

An optional fabric vertical cable riser with zip opening is available to allow power cables to be taken neatly from the floor to the cable tray or directly to the work surface. The riser attaches to the cable tray and has a weighted wire base. Available in black fabric.



Above Desk Power

An optional above desk power module can be added for convenient power access. 2 power outlets, and 2 charging USB ports are included. Above desk power is available with a 10 foot 3 prong plug, or 10 foot hardwire infeed.

PAILO PROJECT TABLES



WORK SURFACES

Project table tops are made with uniformly sized top panels so there is no central joint between the tops.
The grain direction runs with the depth of the surface.

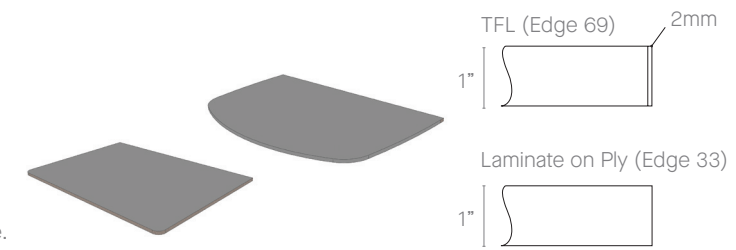

Project tables are available in 62" or 72" depth and lengths of 96", 144", and 192". Surfaces can be specified in TFL (Edge 69) or Laminate faced plywood.

FRAMEWORK



End Legs
Project table end legs are 62" wide. Each end leg has spigots protruding from the frame to allow the beam to be attached into place. Adjustable feet are fitted as standard.



Mid Legs
Mid legs are used to connect starter desks and add-on desks. They have double sided spigots to attach beams to both sides and come with adjustable feet as standard.



Beams
Extruded Aluminum beams are used to connect the legs together. They bolt at each end to the spigots and also through to the top with a channel to hide the attachments. Beams are available to suit the table widths of 96", 144" and 192".

POWER AND ACCESSORIES

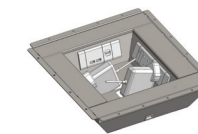

Code A & B
In table power options are available on Pailo project tables. Power option A (4 Power, 4 USB charging) and Power option B (4 Power, 4 USB Charging, and HDMI) are available.



In conjunction with the power units a range of accessories are available. The tray is included with each power unit option, a pen pot and an accessory box can be added if required.

WIRING DIAGRAM

PAILO SINGLE DESK
TYPICAL WIRING LAYOUT

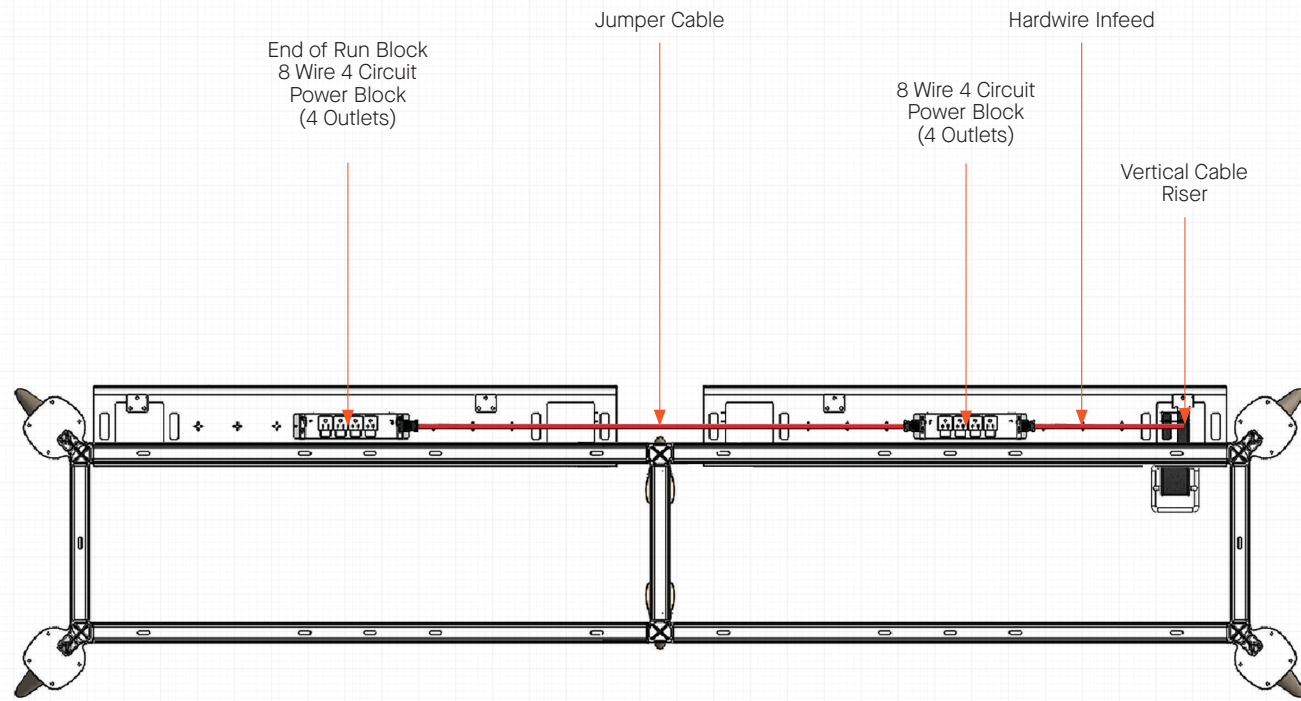
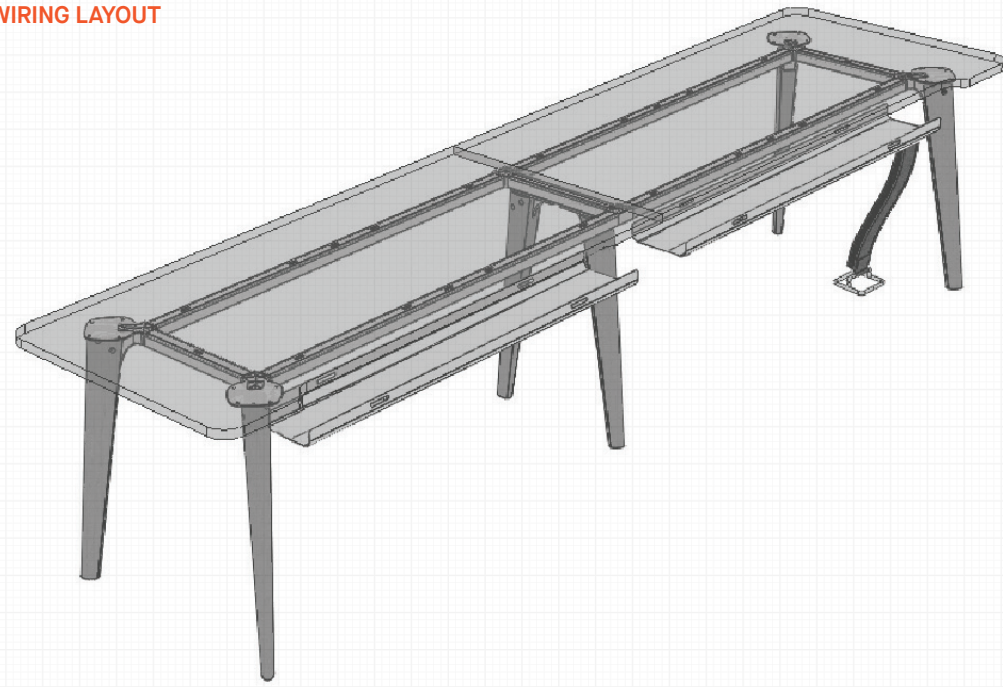

WIRING DIAGRAM

PAILO BACK TO BACK DESKS
TYPICAL BENCH WIRING LAYOUT

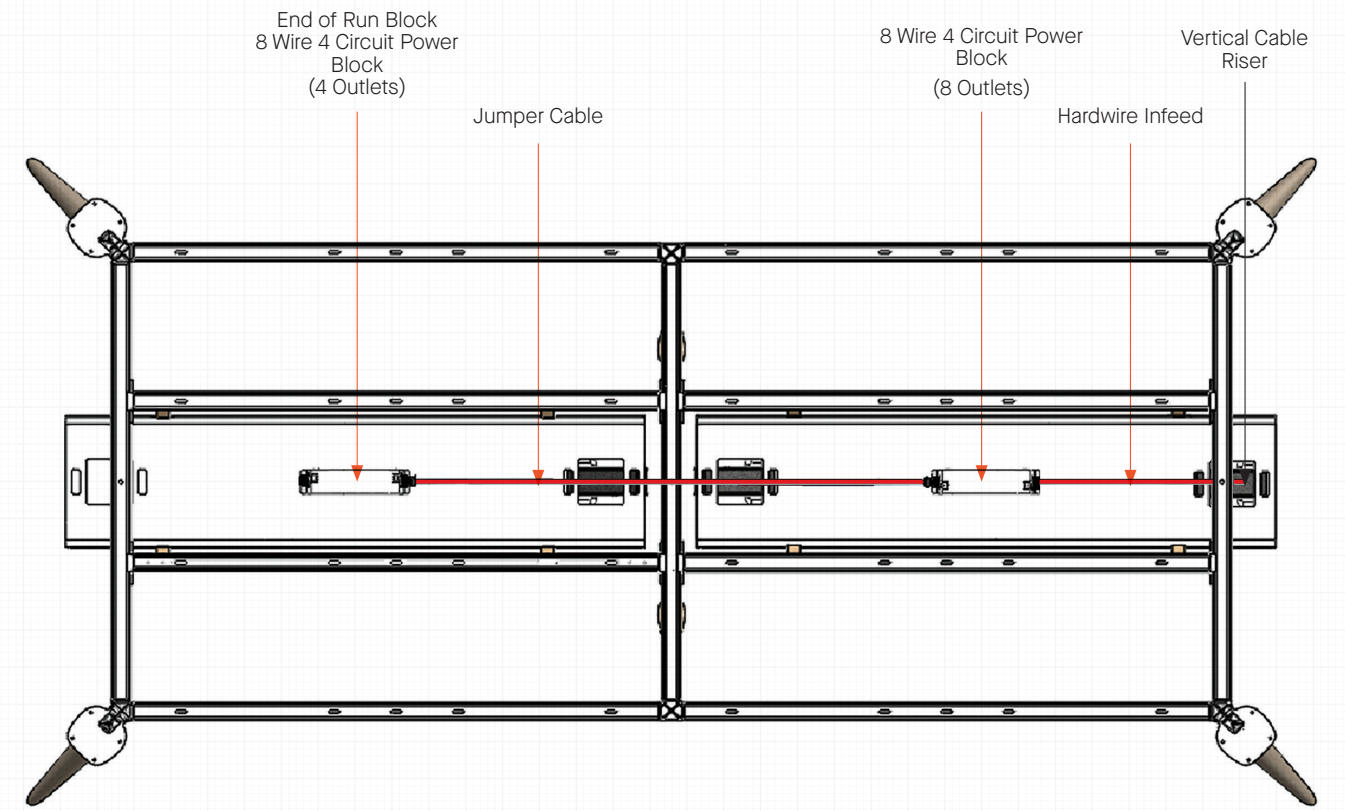
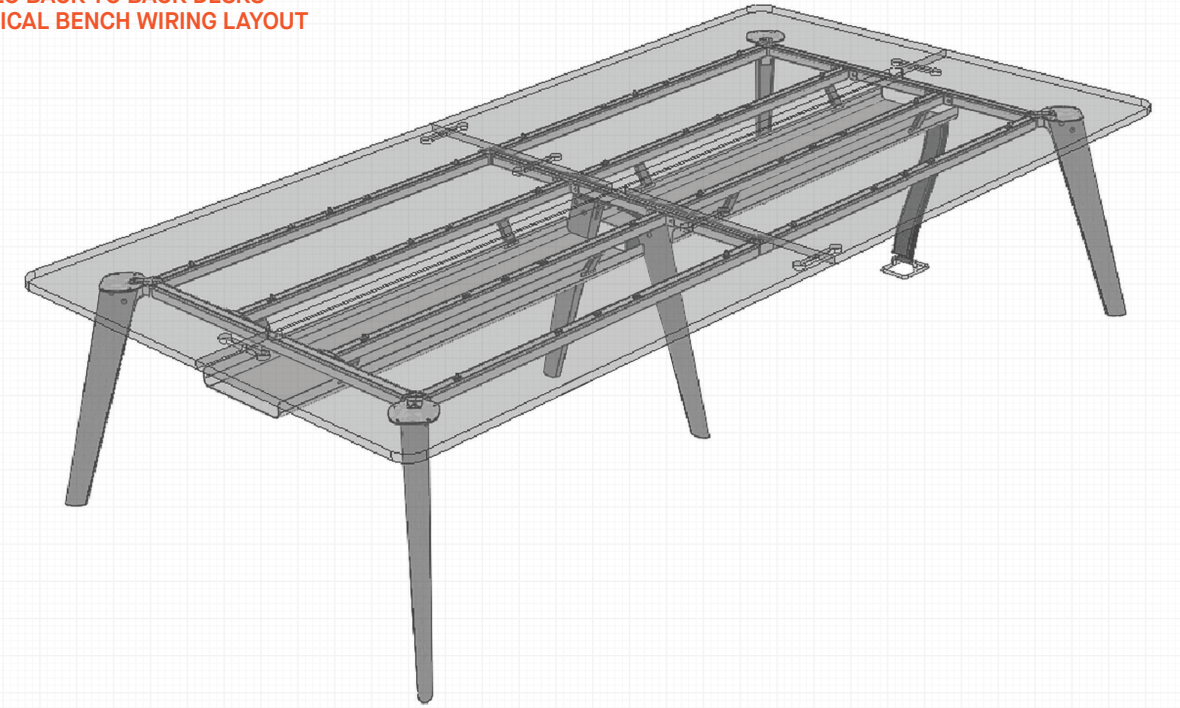

PRODUCT PRICING

PAILO SINGLE DESK

	Width (inch)					Code TFL (Edge 69) Laminate/Ply (Edge 33)
	48" W	54" W	60" W	72" W	78" W	
Executive Single 30" Depth 	PLE4830 3,327 3,932	PLE5430 3,391 4,082	PLE6030 3,447 4,277	PLE7230 3,508 4,461	PLE7830 3,816 4,565	
Single Stand Alone 30" Depth 	PL4830S 3,327 3,932	PL5430S 3,391 4,082	PL6030S 3,447 4,277	PL7230S 3,508 4,461	PL7830S 3,816 4,565	Code TFL (Edge 69) Laminate/Ply (Edge 33)
Single Starter 30" Depth 	PL4830 3,327 3,932	PL5430 3,391 4,082	PL6030 3,447 4,277	PL7230 3,508 4,461	PL7830 3,815 4,565	Code TFL (Edge 69) Laminate/Ply (Edge 33)
Single Add On Mid 30" Depth 	PL4830MA 1,978 2,583	PL5430MA 2,024 2,712	PL6030MA 2,059 2,880	PL7230MA 2,102 3,055	PL7830MA 2,143 3,142	Code TFL (Edge 69) Laminate/Ply (Edge 33)
Single Add On End 30" Depth 	PL4830EA 1,978 2,583	PL5430EA 2,024 2,712	PL6030EA 2,059 2,880	PL7230EA 2,102 3,055	PL7830EA 2,143 3,142	Code TFL (Edge 69) Laminate/Ply (Edge 33)

All prices listed in USD \$

Ships Semi-KD = Knock Down (Needs some assembly)

PRODUCT PRICING

PAILO SINGLE DESK – Cable Management

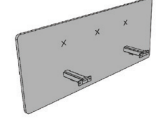
	Width (inch)					Code Price
	48" W	54" W	60" W	72" W	78" W	
Horizontal Cable Tray Single cable tray 	PLCT48 360	PLCT54 380	PLCT60 401	PLCT72 421	PLCT78 442	
Vertical Cable Riser 	PLVCM 262 SEE NOTE 1					Code Price
Cloud Screen with Modesty Panel 	PLMS48 879 SEE NOTE 2	PLMS54 907 SEE NOTE 2	PLMS60 922 SEE NOTE 2	PLMS72 942 SEE NOTE 2	PLMS78 962 SEE NOTE 2	Code Price

Note 1: Only for use with cable trays. Available in Black fabric.
Note 2: Upholstered in Camira Blazer or Camira Synergy.

All prices listed in USD \$
Ships Semi-KD = Knock Down (Needs some assembly)

Finishes & Features Available...

TFL (Edge 69)	HD Highland Oak UM Urban Maple WH White AT Autumn WK Winter Oak SO Strata Oak CW Carini Walnut DN Denim LY Clay LG Light Grey
Laminates	Global Laminates
Frame Colors	Black White Pistachio Totally Orange Peacock Blue
Leg Colors	Matte Clear Finish Black Stain
Accessory Colors	Black White Pistachio Totally Orange Peacock Blue
Screen Fabrics	Camira Blazer Camira Synergy

To specify your desk...

1. Think through the configuration of Desk you require
2. Select the Codes of the individual items you need to achieve your configuration
3. Choose Finishes where appropriate: 'top' finishes / frame color / fabric color / acrylic color
4. Consider supporting product, screens, cable management and accessories

PRODUCT PRICING



PAILO BACK TO BACK BENCH

		Width (inch)					
		48" W	54" W	60" W	72" W	78" W	
Back to Back Stand Alone 62" Depth 	PLB4862	4,220	4,405	4,427	4,571	4,719	Code TFL (Edge 69) Laminate/Ply (Edge 33)
	5,465	5,836	6,112	6,438	6,756		
Back to Back Starter 62" Depth 	PLB4862S	4,220	4,405	4,427	4,571	4,719	Code TFL (Edge 69) Laminate/Ply (Edge 33)
	5,465	5,836	6,112	6,438	6,756		
Back to Back Add On Mid 62" Depth 	PLB4862MA	2,958	3,042	3,125	3,211	3,293	Code TFL (Edge 69) Laminate/Ply (Edge 33)
	4,203	4,473	4,810	5,034	5,845		
Back to Back Add On End 62" Depth 	PLB4862EA	2,958	3,042	3,125	3,211	3,293	Code TFL (Edge 69) Laminate/Ply (Edge 33)
	4,203	4,473	4,810	5,034	5,845		

All prices listed in USD \$
 Ships Semi-KD = Knock Down (Needs some assembly)

PRODUCT PRICING

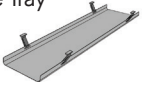
PAILO BACK TO BACK BENCH – Cable Management

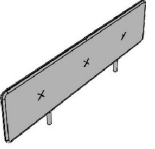
		Width (inch)					
		48" W	54" W	60" W	72" W	78" W	
Horizontal Cable Tray Double Cable Tray 	PLDCT48	433	460	497	527	544	Code Price
	SEE NOTE 1	SEE NOTE 1	SEE NOTE 1	SEE NOTE 1	SEE NOTE 1	SEE NOTE 1	
Vertical Cable Riser 	PLVCM						Code Price
	262					SEE NOTE 2	
Wire Caddy Includes 2 shelves 10" W x 22" H x 22" D 	PLWC						Code Price
	442					SEE NOTE 1	
Cloud Screen 	PLCS48	769	803	840	876	917	Code Price
	SEE NOTES 1 & 3	SEE NOTES 1 & 3	SEE NOTES 1 & 3	SEE NOTES 1 & 3	SEE NOTES 1 & 3	SEE NOTES 1 & 3	

Note 1: Metal may be finished in Black, White, Pistachio, Totally Orange, Peacock Blue. All prices listed in USD \$
 Note 2: Only for use with cable trays. Ships Semi-KD = Knock Down (Needs some assembly)
 Note 3: Upholstered in Camira Blazer or Camira Synergy.

Finishes & Features Available...





TFL (Edge 69)	HD Highland Oak UM Urban Maple WH White AT Autumn WK Winter Oak SO Strata Oak CW Carini Walnut DN Denim LY Clay LG Light Grey
Laminates	Global Laminates
Frame Colors	Black White Pistachio Totally Orange Peacock Blue
Leg Colors	Matte Clear Finish Black Stain
Accessory Colors	Black White Pistachio Totally Orange Peacock Blue
Screen Fabrics	Camira Blazer Camira Synergy

To specify your desk...

1. Think through the configuration of Desk you require
2. Select the Codes of the individual items you need to achieve your configuration
3. Choose Finishes where appropriate: 'top' finishes / frame color / fabric color / acrylic color
4. Consider supporting product, screens, cable management and accessories

PRODUCT PRICING

PAILO SCREENS AND LIGHTING

	Width (inch)					Code
	48" W	54" W	60" W	72" W	78" W	
Stand Alone Gantry 	PLG48 496 SEE NOTE 1	PLG54 524 SEE NOTE 1	PLG60 541 SEE NOTE 1	PLG72 564 SEE NOTE 1	PLG78 626 SEE NOTE 1	Price
Starter Gantry 	PLG48S 496 SEE NOTE 1	PLG54S 524 SEE NOTE 1	PLG60S 541 SEE NOTE 1	PLG72S 564 SEE NOTE 1	PLG78S 626 SEE NOTE 1	Price
Add On Gantry Mid 	PLG48MA 312 SEE NOTE 1	PLG54MA 346 SEE NOTE 1	PLG60MA 393 SEE NOTE 1	PLG72MA 408 SEE NOTE 1	PLG78MA 426 SEE NOTE 1	Price
Add On Gantry End 	PLG48EA 281 SEE NOTE 1	PLG54EA 407 SEE NOTE 1	PLG60EA 393 SEE NOTE 1	PLG72EA 408 SEE NOTE 1	PLG72EA 410 SEE NOTE 1	Price

Note 1: Metal may be finished in Black, White, Pistachio, Totally Orange, Peacock Blue. Wood may be finished in Matte Clear or Black Stain. Finishes must be specified when ordering.

All prices listed in USD \$



Ships Semi-KD = Knock Down (Needs some assembly)

Finishes & Features Available...

TFL (Edge 69)	HD Highland Oak UM Urban Maple WH White AT Autumn WK Winter Oak SO Strata Oak CW Carini Walnut DN Denim LY Clay LG Light Grey
Laminates	Global Laminates
Frame Colors	Black White Pistachio Totally Orange Peacock Blue
Leg Colors	Matte Clear Finish Black Stain
Accessory Colors	Black White Pistachio Totally Orange Peacock Blue
Screen Fabrics	Camira Blazer Camira Synergy

PRODUCT PRICING

PAILO SCREENS AND LIGHTING

	Width (inch)					Code
	48" W	54" W	60" W	72" W	78" W	
Adjustable Drape Screen 	PLAS48 529 SEE NOTES 1 & 2	PLAS54 549 SEE NOTES 1 & 2	PLAS60 570 SEE NOTES 1 & 2	PLAS72 592 SEE NOTES 1 & 2	PLAS78 606 SEE NOTES 1 & 2	Price
Hanging Screen 	PLHS48 550 SEE NOTE 1	PLHS54 569 SEE NOTE 1	PLHS60 596 SEE NOTE 1	PLHS72 613 SEE NOTE 1	PLHS78 630 SEE NOTE 1	Price

Note 1: Upholstered in Camira Blazer or Camira Synergy.

Note 2: Metal may be finished in Black, White, Pistachio, Totally Orange, Peacock Blue





All prices listed in USD \$

Ships Semi-KD = Knock Down (Needs some assembly)

To specify your desk...

1. Think through the configuration of Desk you require
2. Select the Codes of the individual items you need to achieve your configuration
3. Choose Finishes where appropriate: 'top' finishes / frame color / fabric color / acrylic color
4. Consider supporting product, screens, cable management and accessories

PAILO PROJECT TABLES

	Width (inch)			Code TFL (Edge 69) Laminate/Ply (Edge 33)
	96" W	144" W	192" W	
Project Table No Cut Out 62" Depth 	PLMT9662 6,583 9,146	PLMT14462 7,504 11,375	PLMT19262 10,238 15,364	
Boat Shaped Project Table No Cut Out 72" Depth 	PLBMT9672 6,614 9,376	PLBMT14472 7,555 11,699	PLBMT19272 10,305 15,830	
Project Table with cut out for Power Option A or B 62" Depth 	PLMT9662-AB 6,583 9,146 SEE NOTE 1	PLMT14462-AB 7,504 11,375 SEE NOTE 1	PLMT19262-AB 10,238 15,364 SEE NOTE 2	
Boat Shaped Project Table with cut out for Power Option A or B 72" Depth 	PLBMT9672-AB 6,614 9,376 SEE NOTE 1	PLBMT14472-AB 7,555 11,699 SEE NOTE 1	PLBMT19272-AB 10,305 15,830 SEE NOTE 2	

Note 1: If electrical options are specified for these tops, 2 power units are required. Power modules to be ordered separately. Click to see details

Note 2: If electrical options are specified for these tops, 4 power units are required. Power modules to be ordered separately. Click to see details

All prices listed in USD \$
Ships Semi-KD = Knock Down (Needs some assembly)

PAILO PROJECT TABLE POWER OPTIONS

	Electrical Option		
Power Module in Black • In table • Four power outlets • 10 ft power cord with 3-prong plug 	A	ALPUSMDP4P 1,091	Code Price
Power Module in Black • In table • Four power outlets • 1 HDMI • Four powered USB • 10 ft power cord with 3-prong plug Pen Pot Only available in White 	B	ALPUSMDP4PAV 1,739	Code Price
		DATPP 147	Code Price
Pen Box with Lid Accessory Only available in White 		DATPBL 160	Code Price

All prices listed in USD \$
Ships Semi-KD = Knock Down (Needs some assembly)

Finishes & Features Available...

TFL (Edge 69)	HD Highland Oak UM Urban Maple WH White AT Autumn WK Winter Oak SO Strata Oak CW Carini Walnut DN Denim LY Clay LG Light Grey
Laminates	Global Laminates
Frame Colors	Black White Pistachio Totally Orange Peacock Blue
Leg Colors	Matte Clear Finish Black Stain
Accessory Colors	Black White Pistachio Totally Orange Peacock Blue
Screen Fabrics	Camira Blazer Camira Synergy

To specify your desk...

1. Think through the configuration of Desk you require
2. Select the Codes of the individual items you need to achieve your configuration
3. Choose Finishes where appropriate: 'top' finishes / frame color / fabric color / acrylic color
4. Consider supporting product, screens, cable management and accessories

PRODUCT PRICING

PAILO ACCESSORIES

M2 Desk Mounted Adjustable Monitor Arm

Please specify DC if desk clamped or CP for cable port fixed.



M2CLF17DC 638 SEE NOTE 1	M2CLF17CP 638 SEE NOTE 1	Code
		Price
ADPSC 423 SEE NOTE 2		Code
		Price
ADPSS 484		Code
		Price

Above Desk Power (3-Prong Plug)

- Above table
- White or Black
- Two power outlets
- 2 powered USB
- 10 ft power cord with 3-prong plug



Above Desk Power (Hardwire)

- Above table
- White or Black
- Two power outlets
- 2 powered USB
- 10 ft hardwire infeed



Note 1: All monitor arms are compatible with most flat screen monitors. Please ensure monitors have VESA mounting. Consult with the Sales Office for more details.

Note 2: Available in White or Black. Please specify when ordering.

All prices listed in USD \$

Ships Semi-KD = Knock Down (Needs some assembly)

PRODUCT PRICING

PAILO POWER

84 System Hardwire Infeeds. 8 wire 4 Circuit

For Single, Inline, and Bench desk power block options



Single Desk Electrical Kit

- 1 x power block
- 4 x receptacles
- 1 x jumper cable

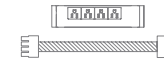

Single Desk End of Run Block

- 1 x power block
- 4 x receptacles



Bench Desk Electrical Kit

- 1 x power block
- 8 x receptacles
- 1 x jumper cable



Bench Desk End of Run Block

- 1 x power block
- 8 x receptacles



Length (inches)			Code
72"	108"	144"	
72HWINF84 231	108HWINF84 296	144HWINF84 363	Price

Single/Inline Desk Power Blocks					Code
Length (inches)					
48"	54"	60"	72"	78"	
EK48SB 8W4C 372	EK54SB 8W4C 382	EK60SB 8W4C 393	EK72SB 8W4C 416	EK78SB 8W4C 426	Price
EKEORSSB 197					Code
					Price

Bench Desk Power Blocks					Code
Length (inches)					
48"	54"	60"	72"	78"	
EK48DSB 8W4C 467	EK54DSB 8W4C 479	EK60DSB 8W4C 490	EK72DSB 8W4C 512	EK78DSB 8W4C 522	Price
EKEORDSB 279					Code
					Price

All prices listed in USD \$

Ships Semi-KD = Knock Down (Needs some assembly)

To specify your desk...

1. Think through the configuration of Desk you require
2. Select the Codes of the individual items you need to achieve your configuration
3. Choose Finishes where appropriate: 'top' finishes / frame color / fabric color / acrylic color
4. Consider supporting product, screens, cable management and accessories

FINISHES

PAILO FINISHES – Standard Top Finishes – TFL (Edge 69)



Carini Walnut



Autumn



Strata Oak

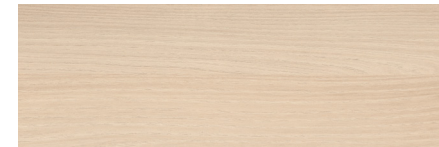

Urban Maple



Highland Oak



Winter Oak

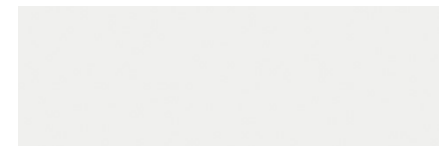

White



Light Gray



Denim

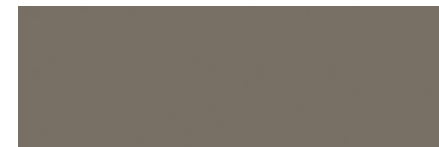

Clay

CONTRASTING EDGE BANDS – For use on TFL (Edge 69) tops only



Ply Effect Edging

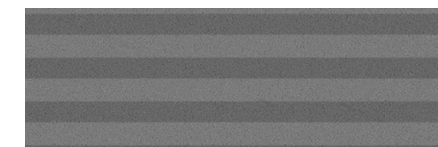

Silver Ply Effect Edging

CONTRASTING EDGE BAND
 All TFL (Edge 69) tops come with a matching edge band as standard. Contrasting edge band can be specified. Please contact customer service if you require a contrasting edge band.

FINISHES

PAILO FINISHES

GLOBAL LAMINATES



Fog



Dark Chocolate



Fossil

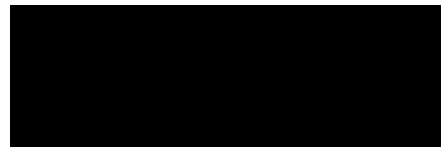

Diamond Black



Mouse

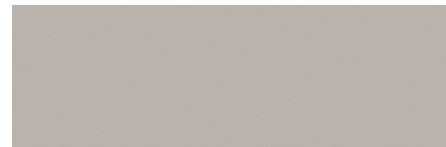

Sarum Gray



Storm



Brite White

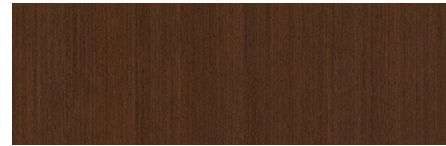

Chestnut Woodline



Oiled Walnut

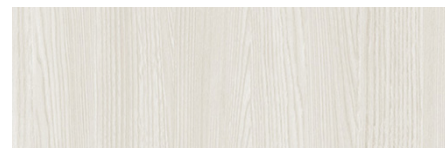

White Ash

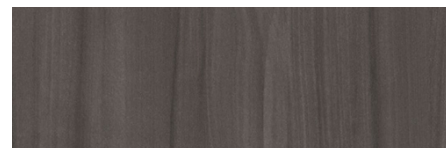

Smoky Brown Pear

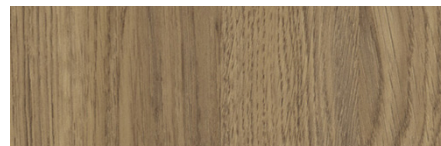

Millennium Oak



Natural Ash

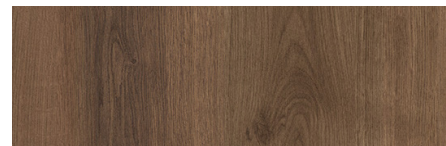

Planked Coffee Oak

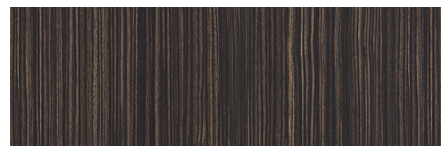

Ebony

Color images above are for reference only. Please verify with actual color sample.

FINISHES

PAILO FINISHES

EDGE FINISHES – For use on Laminate (Edge 33) tops only

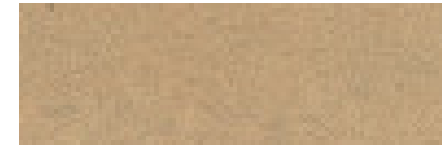

Clear (standard)

Ref Group Number 33

1" Laminate (Edge 33) tops are finished with a square edge that is clear finished as standard.



LEG COLORS



Matte Clear Finish



Black Stain

FRAME FINISHES

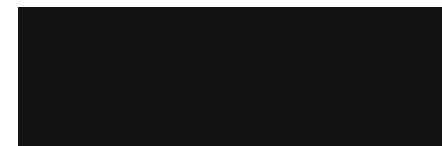

Black



White

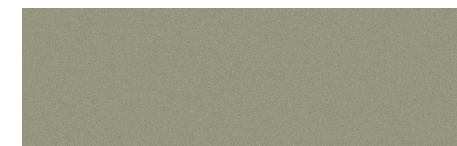

Pistachio



Totally Orange



Peacock Blue

Color images above are for reference only. Please verify with actual color sample.

PAILO FINISHES

VERTICAL CABLE RISER FABRICS

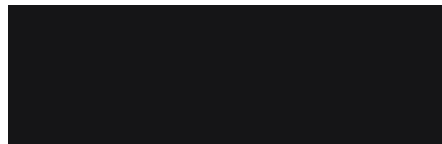

Black

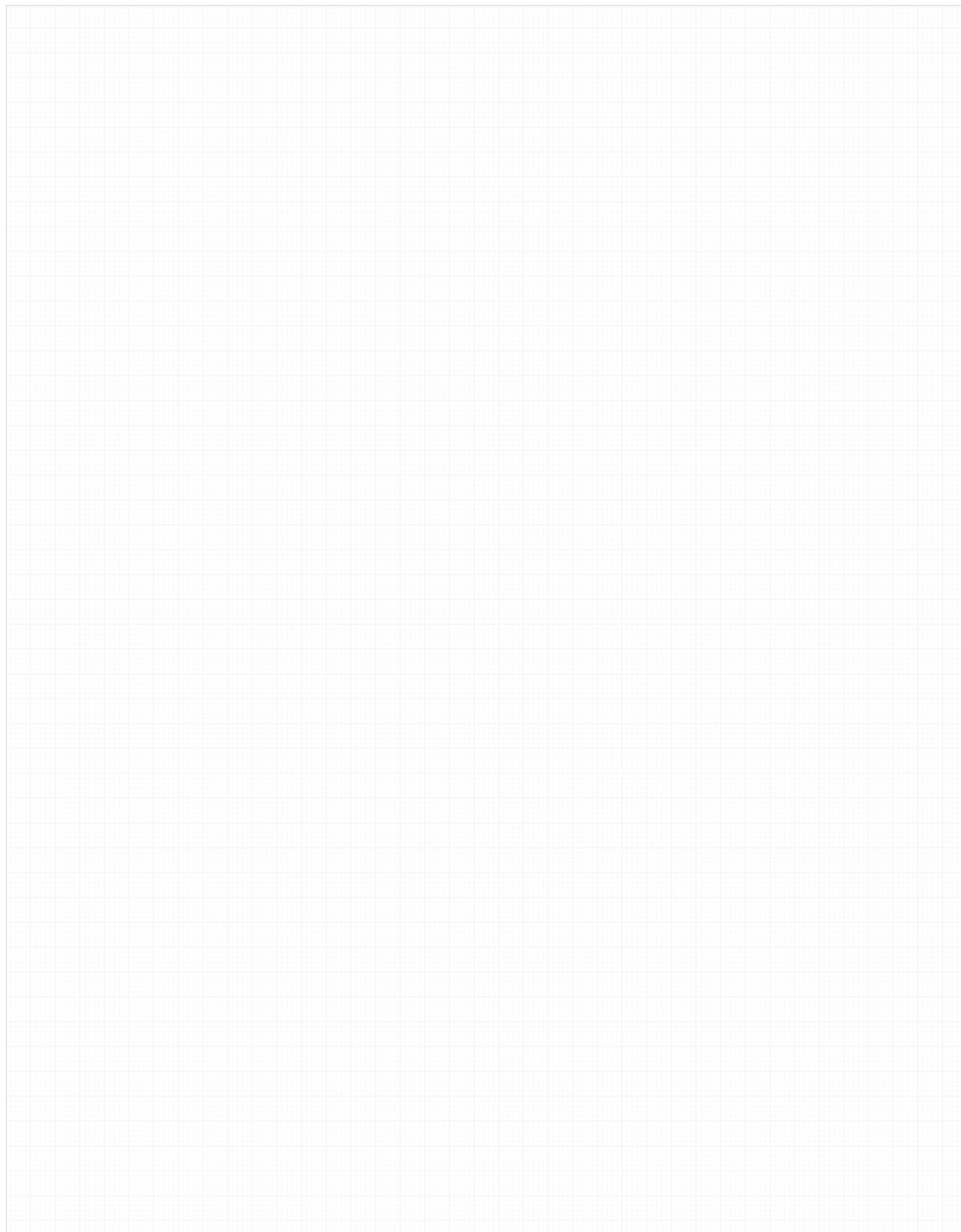

Color images above are for reference only. Please verify with actual color sample.