

**SENATOR**

**HAVEN PODS**

HAVEN PODS



POWERED BY PRIVACY

Advances in technology, changing work patterns and the trend towards open plan workspaces have resulted in an evolution of the modern workplace. Pods create both focused environments within open

plan offices and provide ideal spaces for ad hoc meetings and sharing ideas.

The products across the range offer different acoustic and privacy benefits. Their innovative geometric shape

maximizes space efficiency while reducing surrounding noise.



DESIGN  
Senator

Our team of talented in house designers are responsible for creating elegant, innovative furniture designs which not only look beautiful, but minimise the impact on the world around us.

They come from all over the world, but are based in our Design Center located in a quiet Lancashire village just outside the Ribble Valley. Our dedicated facility is over three floors which include studios, a materials test center and prototyping lab.



- STANDARD FEATURES** (\*Selected models only)
- Internal Steel frame with multi layered foam construction
  - Vertical panels upholstered in Camira Blazer fabric (two-tone is standard)
  - Quick release panel connector system
  - Leveling adjusters
  - 1" TFL work surface\*
  - Work surface power incorporating power outlets, powered USBs.\*
  - Integral under work surface vertical cable management\*

- Low voltage LED task light\*
- Center panel able to support monitor\*
- Integral seat and backrest\*

- OPTIONAL FEATURES** (\*Selected models only)
- Dart accent color
  - Coat Hanger
  - Name Plate
  - Two-tone upholstery on integrated seat units\*

- ACCESSORIES**
- Monitor Arms
  - PU Desk Accessories
  - Desk Top Accessories
  - CPU Holders
  - Electrical Accessories

**MATERIAL CONTENT**  
Components are constructed of the following

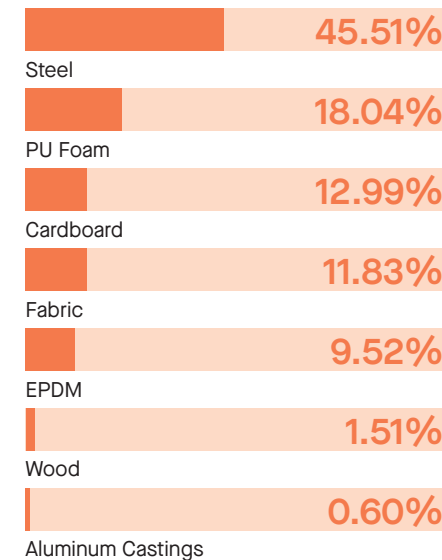

**RECYCLED CONTENT**  
Contains up to 39.75% of Recycled Material

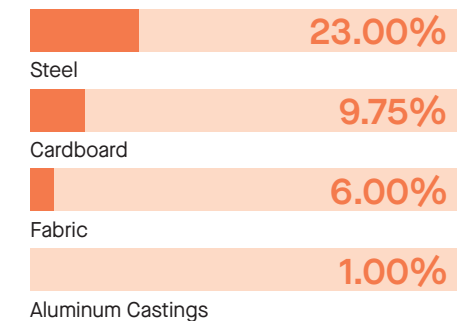

**RECYCLABILITY**  
The range is 99% recyclable

99%

STATEMENT OF LINE

SOLO PODS

- Available
- Not available

Solo  
67" Depth

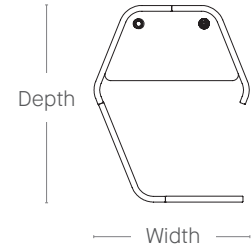

Height (inch)	Width (inch)
55"	55.25" ●
71"	●

DUO & QUAD PODS

- Available
- Not available

Duo  
83.5" Depth

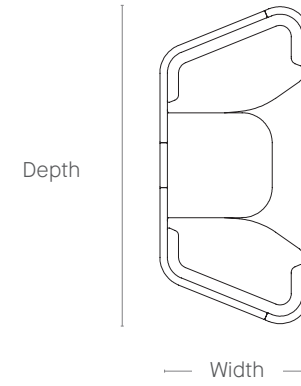

Height (inch)	Width (inch)
55"	39.5" ●
71"	●

Solo Plus  
67" Depth

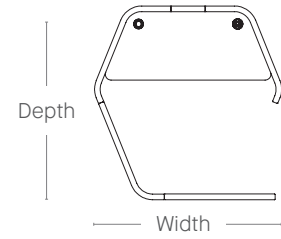

Height (inch)	Width (inch)
55"	65" ●
71"	●

Quad  
78.75" Depth

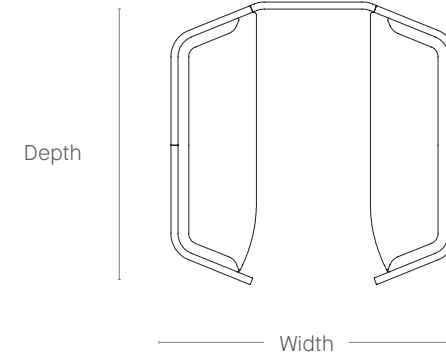

Height (inch)	Width (inch)
55"	78.75" ●
71"	●

STATEMENT OF LINE

TEAM PODS

- Available
- Not available

Team Resource  
98.5" Depth

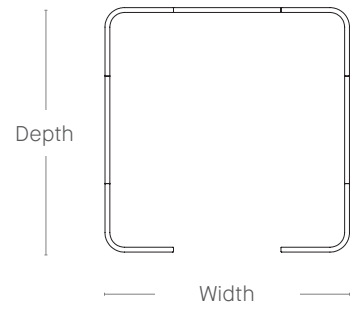

Height (inch)	Width (inch)
55"	98.5" □
71"	●

STATEMENT OF LINE

TEAM PODS

- Available
- Not available

Team Meeting  
126" Depth

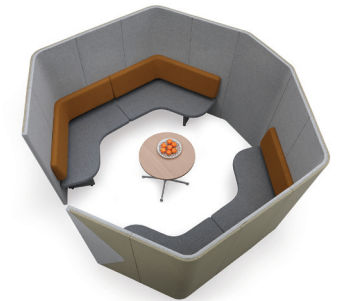
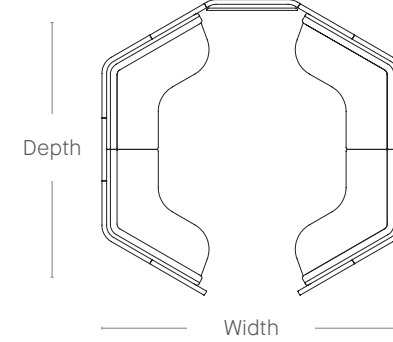

Height (inch)	Width (inch)
55"	126" □
71"	●

Team Work  
118.25" Depth

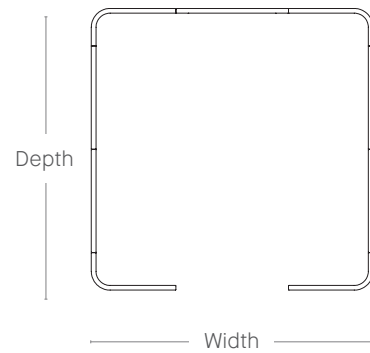

Height (inch)	Width (inch)
55"	118.25" □
71"	●

STATEMENT OF LINE

HAVEN PODS

MID HEIGHT

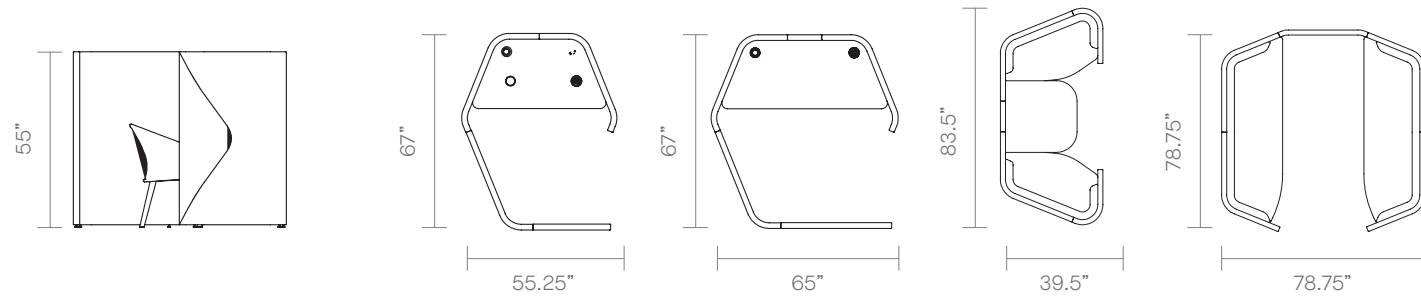

FULL HEIGHT

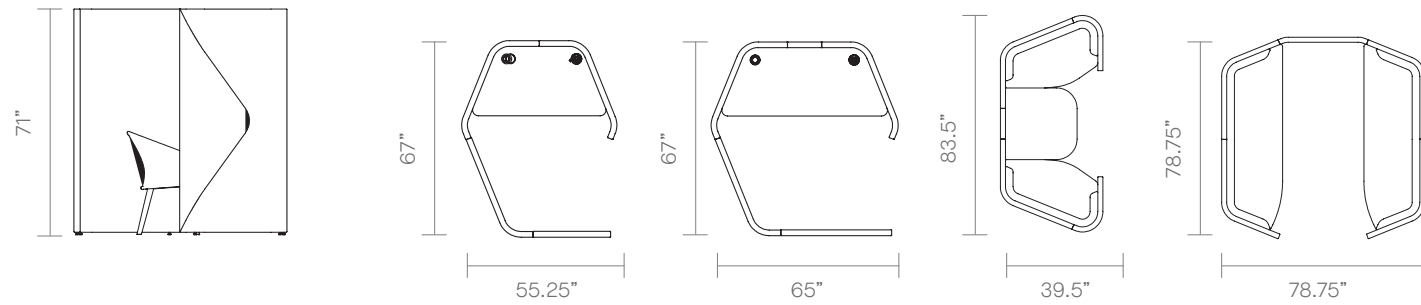

TEAM

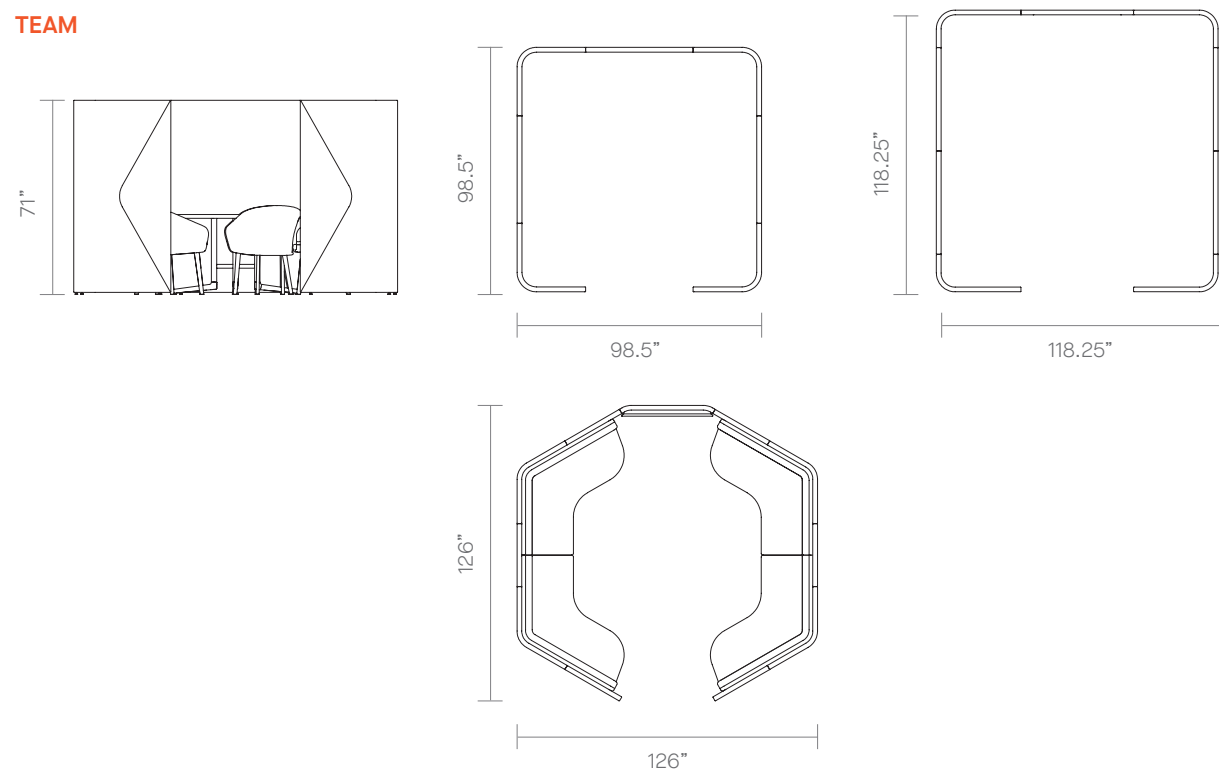

STATEMENT OF LINE

HAVEN PODS

ACCESSORIES & EXTRAS

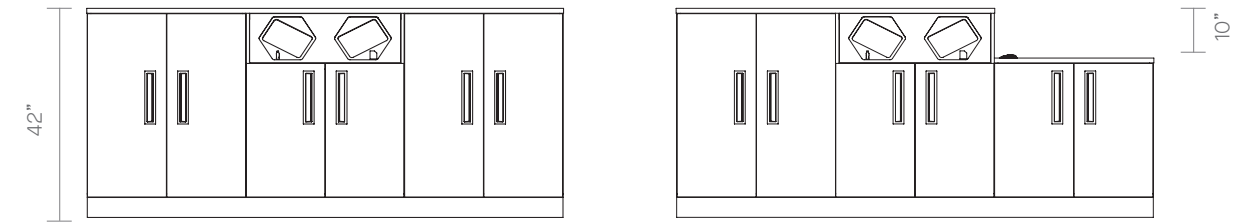
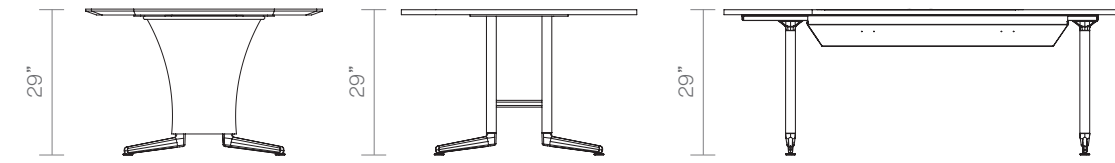

PRODUCT PRICING

PODS – Mid Height

- Standard feature
- Not available
- Optional feature

	HAPDS14L HAPDS14R Solo (Left or Right)	HAPDSP14L HAPDSP14R Solo Plus (Left or Right)	HAPDD14 Duo	HAPDQ14 Quad
Weight	□	□	538lbs	□
Internal steel frame with multi layered foam construction	●	●	●	●
Vertical panels upholstered in Camira Blazer fabric (two-tone is standard)	●	●	●	●
Quick release panel connector system	●	●	●	●
Leveling adjusters	●	●	●	●
1" TFL work surface, Edge 69	●	●	●	□
Integral under work surface vertical cable management	●	●	●	□
Integral seat and backrest	□	□	●	□
Dart accent color (otherwise dart will match interior fabric)	+\$50	+\$50	+\$50	+\$50
Two-tone upholstery on integrated seat units (use the price for the highest grade of the fabric selected)	□	□	+\$100	+\$100

ACCESSORIES

<b>NOD3</b> Integral work surface power includes 1 Power, 2 USB, grommet mount with a 72" cord (Colors – Silver, Black, or White)	\$602	\$602	□	□
<b>HAPCH</b> Coat Hanger				\$116
<b>HAPNP</b> Name Plate (Available in Black or White)				\$110
<b>HAPWBA2</b> A2 Magnetic Dry Wipe Board with Hanger, 24" x 18" (Hanger available in Black or White)				\$232
<b>HAPWBA3</b> A3 Magnetic Dry Wipe Board with Hanger, 18" x 13" (Hanger available in Black or White)				\$219

\* Click here to see available Finishes.

\* Click here to see available Fabrics.

Ships Semi-KD = Knock Down (Needs some assembly)

To specify your pod...

1. Check the Standard Features, Finishes and dimensions and select the version you require.
2. Choose the Fabric combination for the panels and the work surface or table top finish.
3. Select the Fabric Band for the fabric specified for the seat and backrest (where applicable). Refer to main price list for fabric options.
4. N.B. Pods comprise multiple elements; screens, work surface and integrated seating (where applicable) each element is individually coded and priced above and must be added together to achieve the configuration as shown.

PRODUCT PRICING

Code	SPECIFICATION	PLAN VIEW	PRICE								
<b>HAPDS14L</b> · Solo (Left Hand) <b>HAPDS14R</b> · Solo (Right Hand)	Compact single person workspace, comprising four upholstered panels and vertical cable management		9,287  TFL								
<b>HAPDST</b> · Solo Table 45.2" x 23.6"	Solo work surface including pen pot		345								
* Order NOD3 for integral work surface power											
<b>HAPDSP14L</b> · Solo Plus Left Hand) <b>HAPDSP14R</b> · Solo Plus (Right Hand)	Single person workspace comprising five upholstered panels and vertical cable management		11,333  TFL								
<b>HAPDSPT</b> · Solo Plus Table 57.0" x 23.6"	Solo Plus work surface including pen pot		405								
* Order NOD3 for integral work surface power											
<b>HAPDD14</b> · Duo	Compact two person meeting space, comprising five upholstered panels and vertical cable management (see below for seating elements)		10,144								
Fabric Grade	0	1	2	3	4	5	6	7	8	9	C.O.M
<b>HAPDDU</b> · Duo bench seat and back elements	-	2,276	2,351	2,440	2,546	2,656	2,766	2,873	3,091	3,525	2,276 5.25 yds
TFL											
<b>HAPDDT</b> · Duo Table 27.5" x 27.5"	Duo meeting table including Black EPPC support leg		560								
<b>HAPDQ14</b> · Quad	Four person meeting space, comprising five upholstered panels (see below for seating elements)		10,628								
Fabric Grade	0	1	2	3	4	5	6	7	8	9	C.O.M
<b>HAPDQU</b> · Quad bench seat and back elements	-	3,747	3,870	4,009	4,184	4,357	4,534	4,708	5,056	5,754	3,747 8.25 yds
TFL											
<b>HAPDQT</b> · Quad Table 30" X 21"	Quad meeting table and Black EPPC support leg		651								







PRODUCT PRICING

PODS – Full Height

- Standard feature
- Not available
- Optional feature

	HAPDS18L HAPDS18R Solo (Left or Right)	HAPDSP18L HAPDSP18R Solo Plus (Left or Right)	HAPDD18 Duo	HAPDQ18 Quad
Weight	538lbs	□	703lbs	□
Internal steel frame with multi layered foam construction	●	●	●	●
Vertical panels upholstered in Camira Blazer fabric (two-tone is standard)	●	●	●	●
Quick release panel connector system	●	●	●	●
Leveling adjusters	●	●	●	●
1" TFL work surface, Edge 69	●	●	●	●
Integral under work surface vertical cable management	●	●	●	●
Dart accent color (otherwise dart will match interior fabric)	+ \$50	+ \$50	+ \$50	+ \$50
Two-tone upholstery on integrated seat units use the price for the highest grade of the fabric selected)	□	□	+ \$100	+ \$100

ACCESSORIES

<b>NOD3</b> Integral work surface power includes 1 Power, 2 USB, grommet mount with a 72" cord (Colors – Silver, Black, or White)	\$602	\$602	□	□	
<b>HAPCH</b> Coat Hanger				\$116	
<b>HAPNP</b> Name Plate (Available in Black or White)				\$110	
<b>HAPWBA2</b> A2 Magnetic Dry Wipe Board with Hanger, 24" x 18" (Hanger available in Black or White)				\$232	
<b>HAPWBA3</b> A3 Magnetic Dry Wipe Board with Hanger, 18" x 13" (Hanger available in Black or White)				\$219	

\* Click here to see available Finishes.







\* Click here to see available Fabrics.

Ships Semi-KD = Knock Down (Needs some assembly)

To specify your pod...

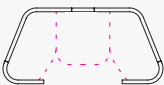
1. Check the Standard Features, Finishes and dimensions and select the version you require.
2. Choose the Fabric combination for the panels and the work surface, table top, or storage finish.
3. Select the Fabric Grade for the seat and backrest (where applicable). Refer to main price list for fabric options.
4. N.B. Pods comprise multiple elements; screens, work surface, storage and integrated seating (where applicable) each element is individually coded and priced above and must be added together to achieve the configuration as shown.

PRODUCT PRICING

Code	SPECIFICATION	PLAN VIEW	PRICE									
<b>HAPDS18L</b> · Solo (Left Hand) <b>HAPDS18R</b> · Solo (Right Hand)	Compact single person workspace, comprising four upholstered panels, vertical cable management		10,348									
· Task Light			980									
			TFL									
<b>HAPDST</b> · Solo Table 45.2" x 23.6"	Solo work surface including pen pot		345									
* Order NOD3 for integral work surface power.												
<b>HAPDSP18L</b> · Solo Plus (Left Hand) <b>HAPDSP18R</b> · Solo Plus (Right Hand)	Single person workspace comprising five upholstered panels and vertical cable management		11,932									
· Task Light			980									
			TFL									
<b>HAPDSPT</b> · Solo Plus Table 57.0" x 23.6"	Solo Plus work surface including pen pot		405									
* Order NOD3 for integral work surface power.												
<b>HAPDD18</b> · Duo	Compact two person meeting space, comprising five upholstered panels and vertical cable management and task light (see below for seating elements)		12,116									
· Task Light			980									
Fabric Grade	0	1	2	3	4	5	6	7	8	9	C.O.M	
<b>HAPDDU</b> · Duo bench seat and back elements	-	2,276	2,351	2,440	2,546	2,656	2,766	2,873	3,091	3,525	2,276	5.25 yds
												TFL
<b>HAPDDT</b> · Duo Table 27.5" x 27.5"	Duo meeting table including Black EPPC support leg		560									
<b>HAPDQ18</b> · Quad	Four person meeting space, comprising five upholstered panels (see below for seating elements)		13,610									
Fabric Grade	0	1	2	3	4	5	6	7	8	9	C.O.M	
<b>HAPDQU</b> · Quad bench seat and back elements	-	3,747	3,870	4,009	4,184	4,357	4,534	4,708	5,056	5,754	3,747	8.25 yds
												TFL
<b>HAPDQT</b> · Quad Table 30" X 21"	Freestanding meeting table with Black EPPC column and base		651									

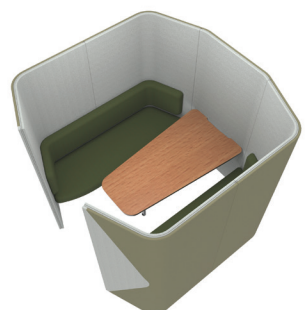

PRODUCT PRICING

PODS – Team

- Standard feature
- Not available
- Optional feature

	HAPDTR18 Team Resource	HAPDTW18 Team Work	HAPDTM18 Team Meeting
Weight	□	□	□
Internal steel frame with multi layered foam construction	●	●	●
Vertical panels upholstered in Camira Blazer fabric (two-tone is standard)	●	●	●
Quick release panel connector system	●	●	●
Leveling adjusters	●	●	●
Integral under work surface vertical cable management	□	●	□
Integral seat and backrest	□	□	●
Center panel able to support monitor	□	●	□
Dart accent color (otherwise dart will match interior fabric)	+ \$50	+ \$50	+ \$50
Two-tone upholstery on integrated seat units use the price for the highest grade of the fabric selected)	□	□	+ \$100

ACCESSORIES

<b>HAPCH</b> Coat Hanger	\$116	
<b>HAPNP</b> Name Plate (Available in Black or White)	\$110	
<b>HAPWBA2</b> A2 Magnetic Dry Wipe Board with Hanger, 24" x 18" (Hanger available in Black or White)	\$232	
<b>HAPWBA3</b> A3 Magnetic Dry Wipe Board with Hanger, 18" x 13" (Hanger available in Black or White)	\$219	





\* Click here to see available Finishes.

\* Click here to see available Fabrics.

Ships Semi-KD = Knock Down (Needs some assembly)

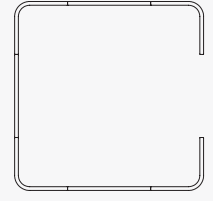
PRODUCT PRICING

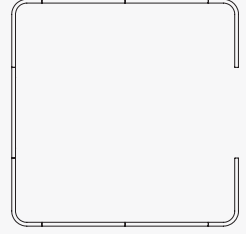
Code SPECIFICATION PLAN VIEW PRICE

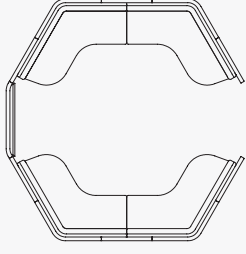
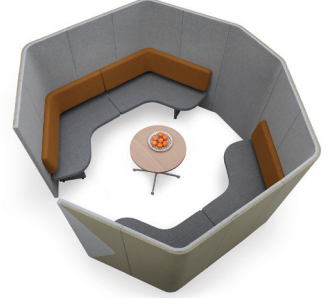
<b>HAPDTR18</b> • Team Resource	Team workspace, comprising seven upholstered panels.		15,168	
<b>HAPDTW18</b> • Team Work	Team workspace, comprising seven upholstered panels and one upholstered screen mount panel.		19,419	
<b>HAPDTM18</b> • Team Meeting	Team meeting space, comprising eleven upholstered panels and one upholstered screen mount panel. Panel is suitable for a 42" TV. (see below for seating elements)		23,570	

Fabric Grade	0	1	2	3	4	5	6	7	8	9	C.O.M
<b>HAPDTMU</b> • Team Meeting bench seat and back elements	-	6,477	6,767	7,096	7,509	7,918	8,332	8,744	9,567	11,213	6,477 17 yds

To specify your pod...

1. Check the Standard Features, Finishes and dimensions and select the version you require.
2. Choose the Fabric combination for the panels and the work surface, table top, or storage finish.
3. Select the Fabric Grade for the seat and backrest (where applicable). Refer to main price list for fabric options.
4. N.B. Pods comprise multiple elements; screens, work surface, storage and integrated seating (where applicable) each element is individually coded and priced above and must be added together to achieve the configuration as shown.



## PODS – Accessories & Extras

- Standard feature
- Not available
- Optional feature

Weights	□
1" TFL top, Edge 69	●
Black EPPC leg column	●
Black EPPC leg base	●
Leveling feet	●

**AL48RD**  
Ad-Lib Round Meeting Table

	HAPD7RSC/1 Team resource recycling storage unit	HAPDTRSC/2L Team resource recycling storage unit split height	HAPDTRSC/2R Team resource recycling storage unit split height
Weights	□	□	□
1" TFL top panel	●	●	●
TFL carcass	●	●	●
Integrated shelves	●	●	●
Recycle compartment with integrated bins	●	●	●
Integral locking	●	●	●

\* Click here to see available Finishes.

\* Click here to see available Fabrics.

*Ships Semi-KD = Knock Down (Needs some assembly)*

## TABLES

<b>ALP48RD</b> • Ad-Lib round meeting table (Team Work Pod only) • 29"h x 48" Dia.	TFL 2,458	
--	--------------	---

## STORAGE

<b>HAPDTRSC/1</b> • Team resource Recycling storage unit • 94.5" x 25.25" x 42.25" high	TFL 4,641	
<b>HAPDTRSC/2L</b> • Team resource Recycling storage unit split height • 94.5" x 25.25" x 42.25" / 34.25" high	4,641	
<b>HAPDTRSC/2R</b> • Team resource Recycling storage unit split height • 94.5" x 25.25" x 42.25" / 34.25" high	4,641	

## To specify your pod...

1. Check the Standard Features, Finishes and dimensions and select the version you require.
2. Choose the Fabric combination for the panels and the work surface, table top, or storage finish.
3. Select the Fabric Grade for the seat and backrest (where applicable). Refer to main price list for fabric options.
4. N.B. Pods comprise multiple elements; screens, work surface, storage and integrated seating (where applicable) each element is individually coded and priced above and must be added together to achieve the configuration as shown.

## HAVEN PODS

### FINISH OPTIONS

Vertical panels upholstered in Camira Blazer fabric two tone is standard

### BLAZER FABRIC FINISHES

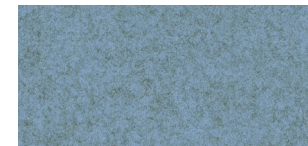

Plymouth

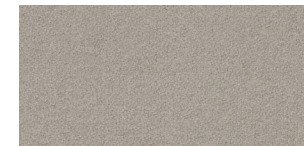

Fairfield

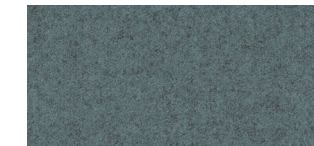

Latymer



Silcoates



Silverdale



St Andrews

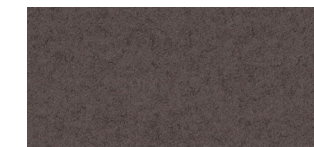

Trevelyan

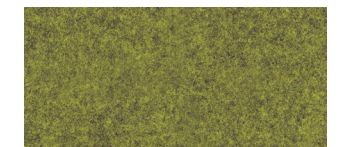

Ulster



Wellington



Wesley

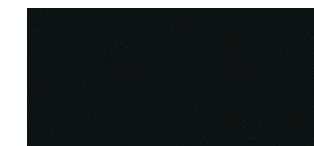

Napier

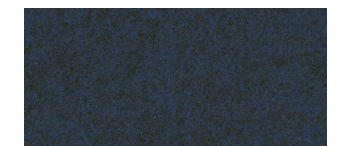

Newcastle



Newport

### FRAME / LEG FINISHES



Black

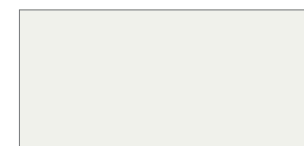

White

# FINISHES

Color images above are for reference only. Please verify with actual color sample.

PODS STANDARD TOP & STORAGE FINISHES – TFL



Carini Walnut



Autumn



Strata Oak



Urban Maple



Highland Oak



Winter Oak

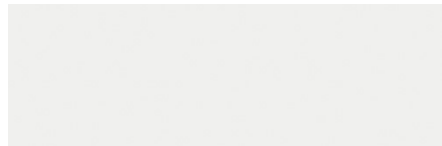

White



Light Gray



Denim



Clay

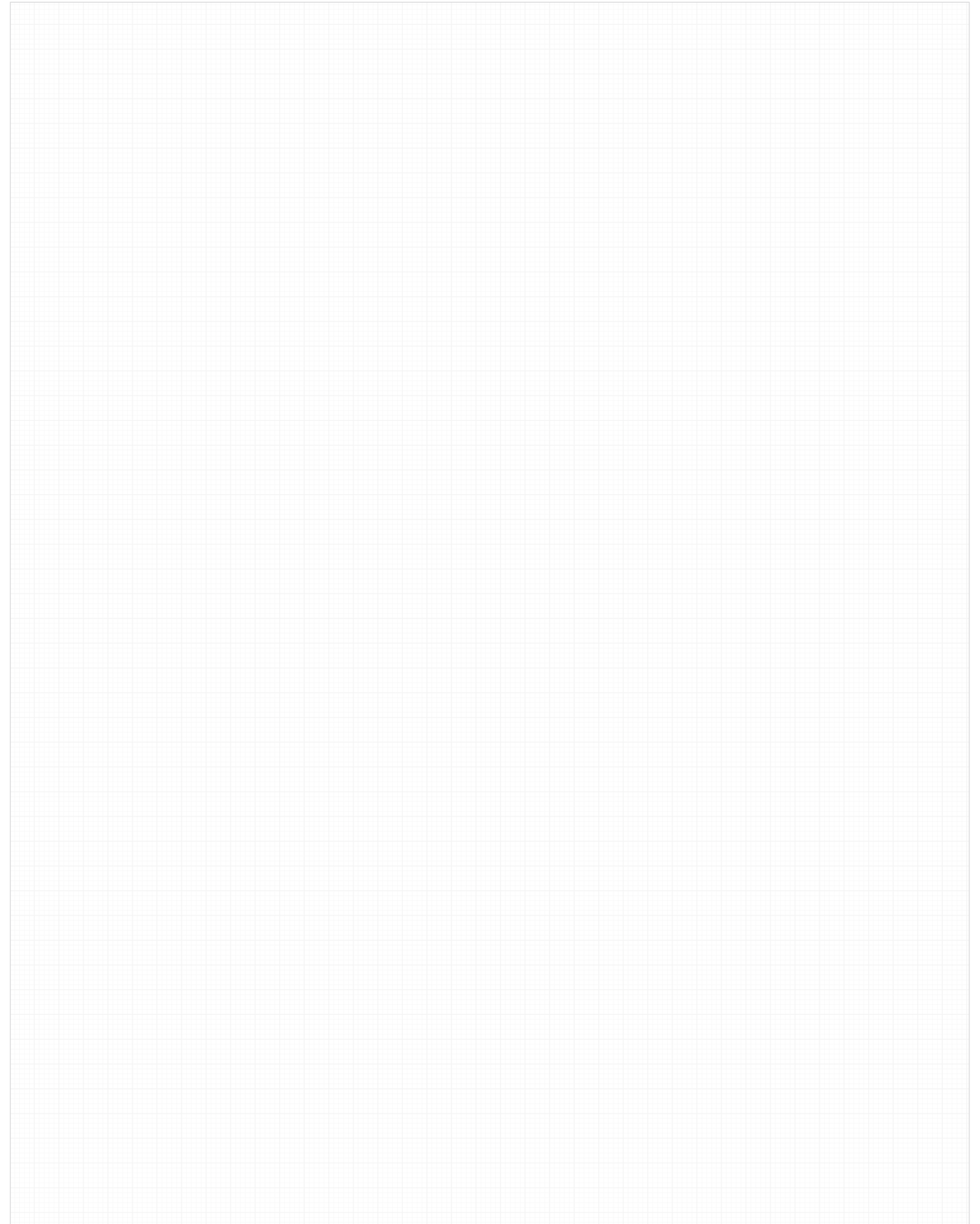

Color images above are for reference only. Please verify with actual color sample.